



Prosilica GT

4400

- -20° C to +65° C (ambient temperature)
- PoE
- IEEE 1588 PTP
- Trigger over Ethernet
- Auto iris

Engineered for every environment

High-resolution cameras for demanding applications

Prosilica GT 4400 with Sony IMX367 runs 6.1 frames per second at 19.7 MP resolution.

The rugged housing optimized for heat dissipation makes Prosilica GT the ideal solution for harsh environments. The various lens control options allow constant adjustment of the image brightness to changing light conditions. Offering resolutions of up to 31 megapixels, they are ideal for high-definition imaging applications with demanding requirements of robustness and design-in flexibility.

Easy software integration with Allied Vision's [Vimba Suite](#) and compatibility to the most popular [third party image-processing libraries](#).

See the [Modular Concept](#) for lens mount, housing variants, optical filters, case design, and other modular options. See the [Customization and OEM Solutions](#) webpage for additional options.

Specifications

Interface	IEEE 802.3 1000BASE-T, IEEE 802.3af (PoE)
Resolution	4432 (H) × 4436 (V)
Sensor	Sony IMX367
Sensor type	CMOS
Shutter mode	GS (Global shutter)
Sensor size	Type 4/3
Pixel size	3.45 μm × 3.45 μm
Lens mounts (available)	F-Mount
Max. frame rate at full resolution	6.12 fps
ADC	12 Bit
Image buffer (RAM)	128 MByte

Imaging performance

Imaging performance data is based on the evaluation methods in the EMVA 1288 Release 3.1 standard for characterization of image sensors and cameras. Measurements are typical values for monochrome models measured at full resolution without optical filter.

Quantum efficiency at 529 nm	64 %
Temporal dark noise	2.3 e ⁻
Saturation capacity	10300 e ⁻
Dynamic range	72 dB
Absolute sensitivity threshold	2.7 e ⁻

Output

Bit depth	12-bit
Monochrome pixel formats	Mono8, Mono12Packed, Mono12
YUV color pixel formats	YUV411Packed, YUV422Packed, YUV444Packed
RGB color pixel formats	RGB8Packed, BGR8Packed
Raw pixel formats	BayerRG8, BayerRG12, BayerRG12Packed

General purpose inputs/outputs (GPIOs)

TTL I/Os	1 input, 2 outputs
----------	--------------------

Opto-isolated I/Os	1 input, 2 outputs
RS232	1

Operating conditions/dimensions

Operating temperature	-20 °C to +50 °C housing (without condensation)
Power requirements (DC)	7 to 25 VDC AUX or IEEE 802.3at Type 1 PoE
Power consumption	External power: 5.0 W at 12 VDC Power over Ethernet: 6.2 W
Mass	372 g
Body dimensions (L × W × H in mm)	96 × 66 × 53.3 (including connectors)

Quantum efficiency

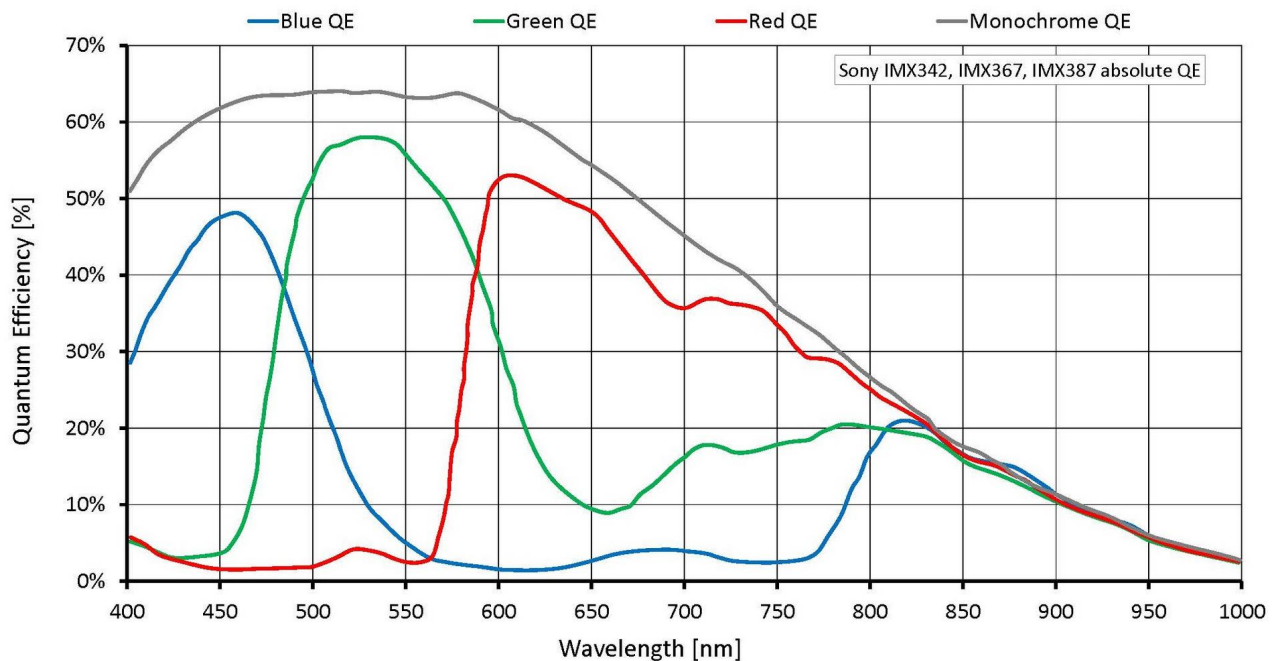

Features

Image control: Auto

- Auto exposure
- Auto gain
- Auto white balance (color models)

Image control: Other

- Binning
- Black level
- Color transformation (incl. hue, saturation; color models)
- Decimation
- DPC (defect pixel correction)
- Gamma
- LUT (look-up table)
- Reverse X/Y
- ROI (region of interest)

Camera control

- Acquisition frame rate
- Auto iris
- Bandwidth control
- EF Mount lens control
- Event channel
- Firmware update in the field
- I/O and trigger control
- Image chunk data
- Stream hold
- Temperature monitoring
- ToE (trigger over Ethernet, action commands)
- User sets

Technical drawing

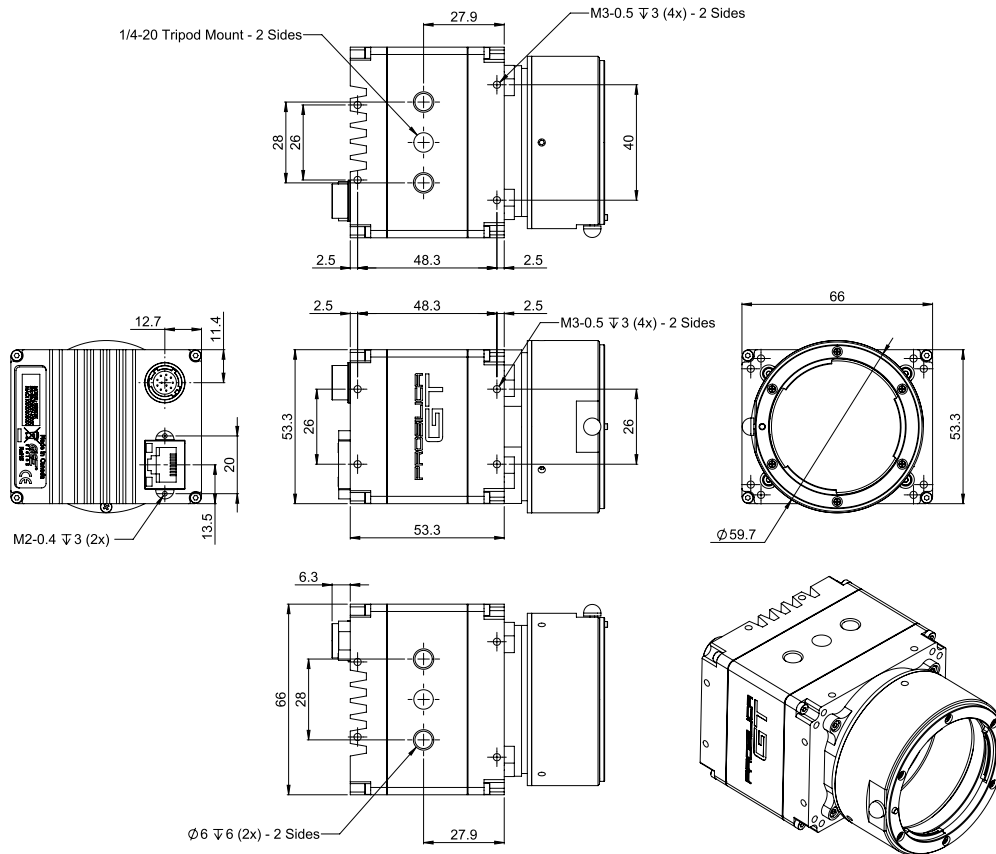

Applications

Prosilica GT4400 is ideal for a wide range of applications including:

- Industrial inspection including display inspection, surface inspection, semiconductor packaging inspection, print inspection, 2D/3D metrology, laser beam profiling, and automated optical inspection
- Outdoor imaging applications including railway inspection, aerial imaging, traffic and transportation, surveillance, and defense
- Medical and life sciences applications including lab and biomedical imaging, pharma and cosmetic inspection, track and trace applications
- Archival imaging of documents and digitization of film