

DATA SHEET

# Interface cable

USB 3.0 Type-A to Micro-B with screw locks, 1.0 m

**Product code**  
12326

**V1.0.0**  
2019-May-17



## NOTICE

### Malfunctions and short circuits by damaged cables and connectors

Provide sufficient strain relief for all cable connections.

## Cable and connector dimensions

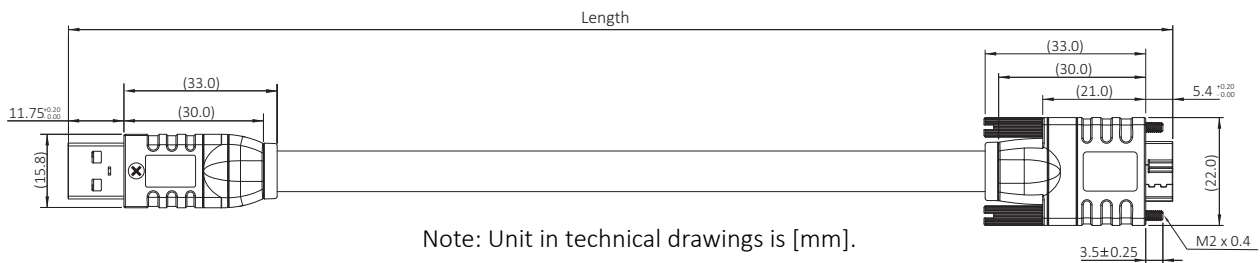

Connector 1:  
USB 3.0 Type-A male

Cable

Connector 2:  
USB 3.0 Micro-B male

## Connector 1 and adapter description

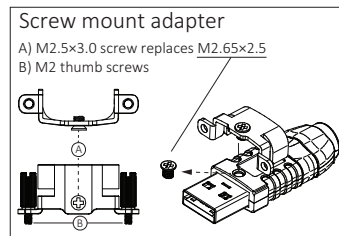
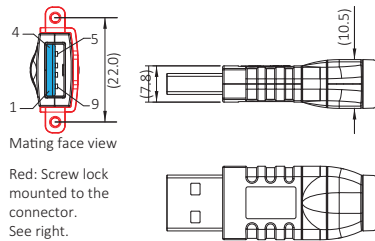

## Connector 2 description

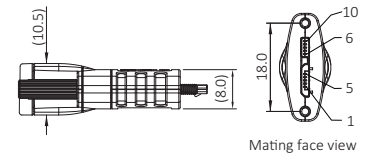

## Wiring diagram

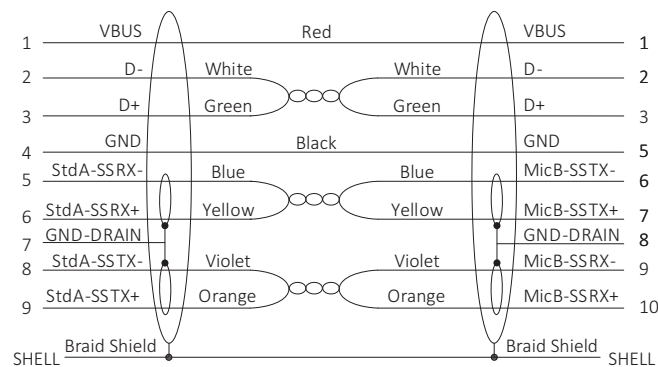

## Specifications

Feature	Specification
Length	1.0 m ± 50 mm
Diameter	6.2 mm
Classifications	Industrial grade for static applications
Static bending radius	≥ 62 mm
Dynamic bending radius	For static applications only
Operating temperature range	-10°C to +60°C
Regulations	2011/65/EU, incl. amendment 2015/863/EU (RoHS), China RoHS, REACH, cable material: UL2725